



### Electro-hydraulic Proportional Flow and Direction Control Valve

10 to 500 ℓ /min  
25MPa

### Features

This valve uses a DC solenoid in a traditional 4-way solenoid valve to create a solenoid valve capable of both direction switching and high-speed control. The lineup consists of the direct system 01 size and the pilot system 03, 04, and 06 sizes.

Direction control is performed by supplying input

current to one of the two proportional solenoid valves, and the size of the flow rate is controlled in accordance with the size of the input current.

This type of valve can be used for remote control and shockless acceleration and deceleration control, and for simple configuration of hydraulic circuits.

#### ● Handling

##### 1 Air Bleeding

In order to ensure stable control, loosen the air vent and bleed air from the valve before starting operation. For details, see the user's guide.

##### 2 T Port Piping

When configuring piping, ensure that the T port (pilot valve T port for the G03, G04, and G06 sizes) is filled with operating fluid.

##### 3 Manual Adjusting Screw

For the initial adjustment or when there is no input current to the valve due to an electrical problem or some other reason, the valve can be operated and valve pressure can be increased by rotating the manual adjustment screw clockwise (rightward). Normally, the manual adjusting screw should be rotated back fully to the left (counterclockwise).

##### 4 Valve Mounting Orientation

Install the valve so the spool axis line is horizontal.

##### 5 Combining with a Pressure Compensation Valve

Use of the optional pressure compensation kit is recommended when higher precision flow rate control is required or in high-pressure applications. For details, see page I-20.

##### 6 If pilot pressure (ESD-G03, G04, G06) exceeds 9MPa {92kgf/cm<sup>2</sup>}

use a modular type P port reduction valve (OG-G01-P1-21) at a setting of 2MPa {20kgf/cm<sup>2</sup>}.

##### 7 On a system that requires large brake pressure during deceleration or a system that uses a vertical cylinder, equip a counter balance valve.

Use a single rod, if the rod exit is not slowed sufficiently, use a counter balance valve on the rod. Use of a G01 modular filter (Absolute: 8μm) is also helpful. (Example: Taisei Kogyo Co., Ltd. MVF-01-8C-1)

(Continued on next page)

### Specifications

Item	Model No.	ESD-G01-10 20 -12	ESD-G03-40 - (**)-12 80	ESD-G04-140 - (**)-12	ESD-G06-250 - (**)-13
Maximum Operating Pressure MPa{kgf/cm <sup>2</sup> }		25{25.5}			
Rated Flow Rate ℓ /min		10/20{Note 1}	40/80{Note 1}	140{Note 1}	250{Note 1}
Maximum Flow Rate ℓ /min		25{Note 2}	100{Note 2}	140{Note 2}	250{Note 2}
Pilot Pressure MPa{kgf/cm <sup>2</sup> }		—	At least 1.0{10}{Note 3}		
Pilot Flow Rate ℓ /min		—	At least 2{Note 4}	At least 3{Note 4}	At least 5{Note 4}
T Port Allowable Back Pressure MPa{kgf/cm <sup>2</sup> }	2.5{25.5}	Internal Drain: 2.5 {25.5} External Drain: 21 {214}			
Rated Current mA		850			
Coil Resistance Ω		20{20°C}			
Hysteresis %		5 max.{Note 5}			
Response Time s		0.04{Note 6}	0.05{Note 6}	0.08{Note 6}	0.1{Note 6}
Weight kg		2.2	7	9.2	15

- Note 1. Value when pressure drop volume to P→A and P→B is ΔP = 1.0MPa {10kgf/cm<sup>2</sup>}.  
 2. Indicates maximum throughput volume value between each port.  
 3. Indicates differential between the pilot port and tank port, or drain port.  
 4. Value when 0.1 second is assumed for the response time from zero to the rated flow volume.  
 5. Value when a Nachi-Fujikoshi special amplifier is used.  
 6. Response time is typical value for a supply pressure of 14MPa {143kgf/cm<sup>2</sup>} and fluid temperature of 40°C (kinematic viscosity: 40mm<sup>2</sup>/s).

### Understanding Model Numbers

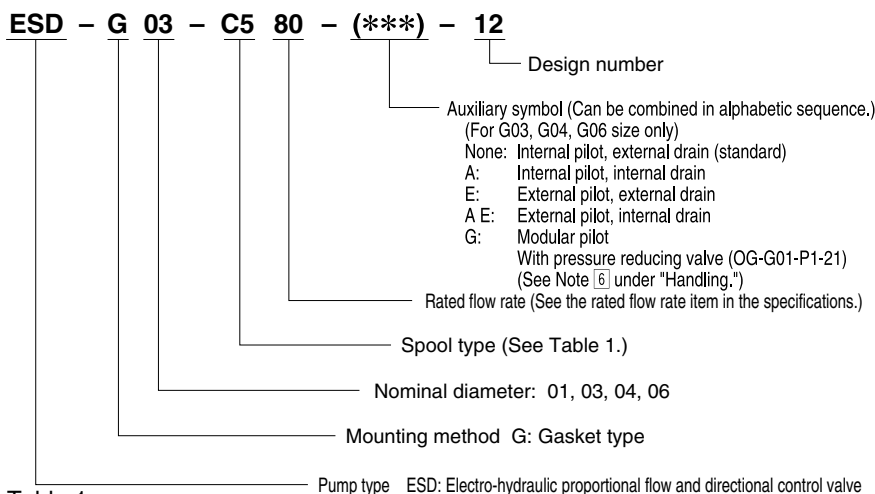

Table 1

Spool Type	Hydraulic Circuit		
	ESD-G01	ESD-G03, G04	ESD-G06
C5			
C6S			

# Installation Dimension Drawings

9 Bundled Accessories (Valve Mounting Bolts)

## ESD-G01

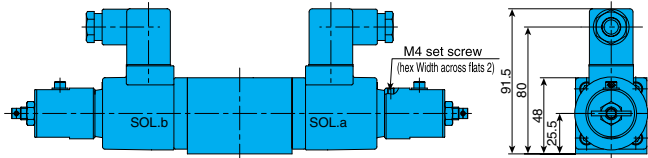
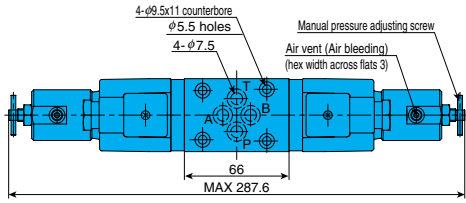

Model No.	Bolt Size	Q'ty	Tightening Torque N·m(kgf·cm)
ESD-G01	M 5 × 45 ℓ	4	5 to 7{ 51 to 71 }
ESD-G03	M 6 × 35 ℓ	4	10 to 13{ 102 to 133 }
ESD-G04	M 6 × 45 ℓ M10 × 50 ℓ	2	10 to 13{ 102 to 133 }
ESD-G06	M12 × 60 ℓ	4	45 to 55{ 460 to 560 }
		6	60 to 70{ 610 to 715 }

For information about sub plates, see MSA-01Y-10 on page I-3.

Gasket Surface Dimensions  
(ISO 4401-03-02-0-94)

10 Use an operating fluid that conforms to the both of the following.

Oil temperature: -20 to 70°C Viscosity: 12 to 400mm<sup>2</sup>/s The recommended viscosity range is 15 to 60mm<sup>2</sup>/s.

## ESD-G03

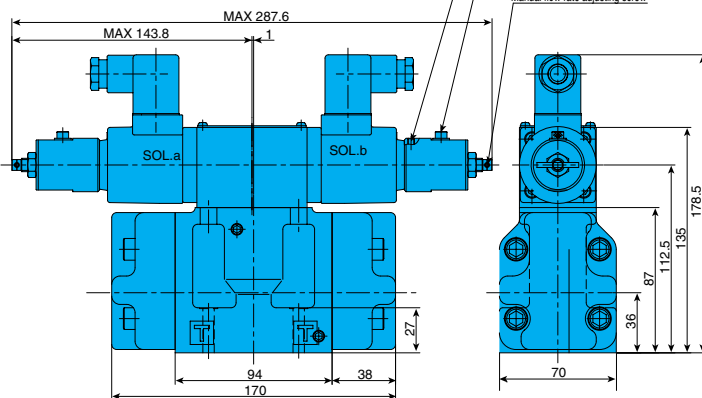
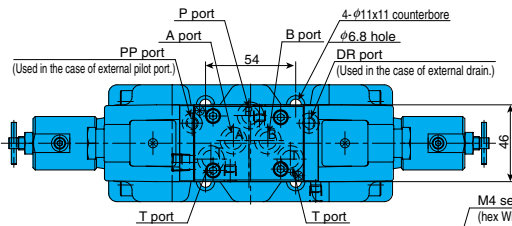

ESD-G03 Mounting Gasket Surface Dimensions  
Gasket Surface Mounting Dimensions (ISO4401-05-0-94)

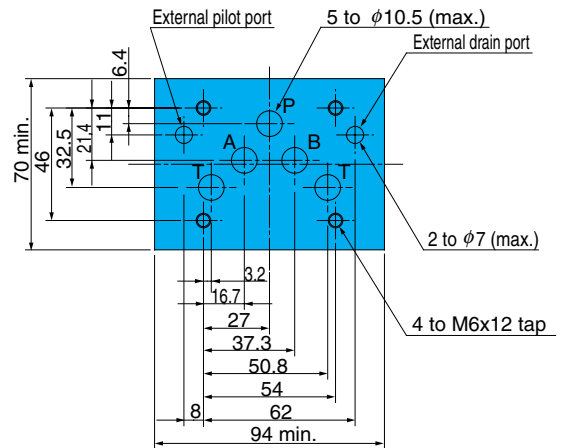

## ESD-G04

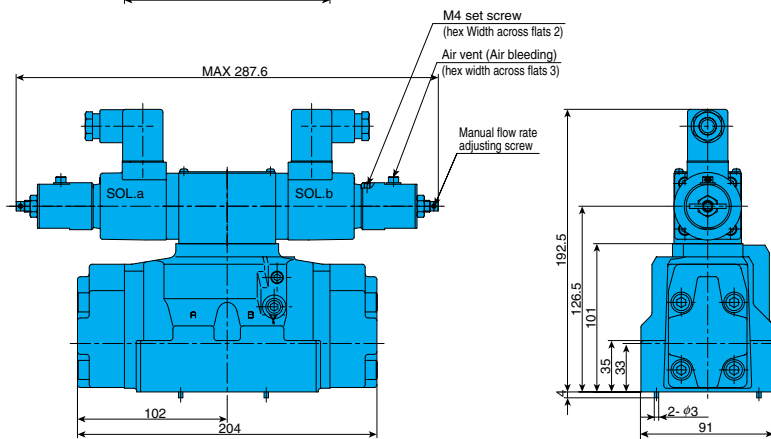
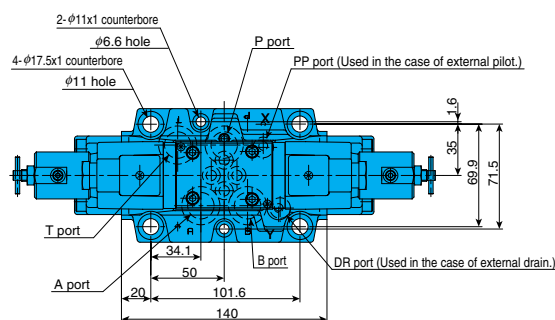

- Auxiliary symbol G: Equipping a modular type pilot reduction valve increases the height by 40mm.
- The gasket surface dimensions comply with the ISO standards shown below.  
ESD-G04...ISO 4401-07-06-0-94  
ESD-G06...ISO 4401-08-07-0-94  
ESD-G10...ISO 4401-10-08-0-94

Note) The coil cover has an M4 set screw. To change the air vent orientation, loosen the M4 screw and then rotate the cover. After bleeding air, tighten the cover and then secure it with the M4 screw.

# ESD-G06

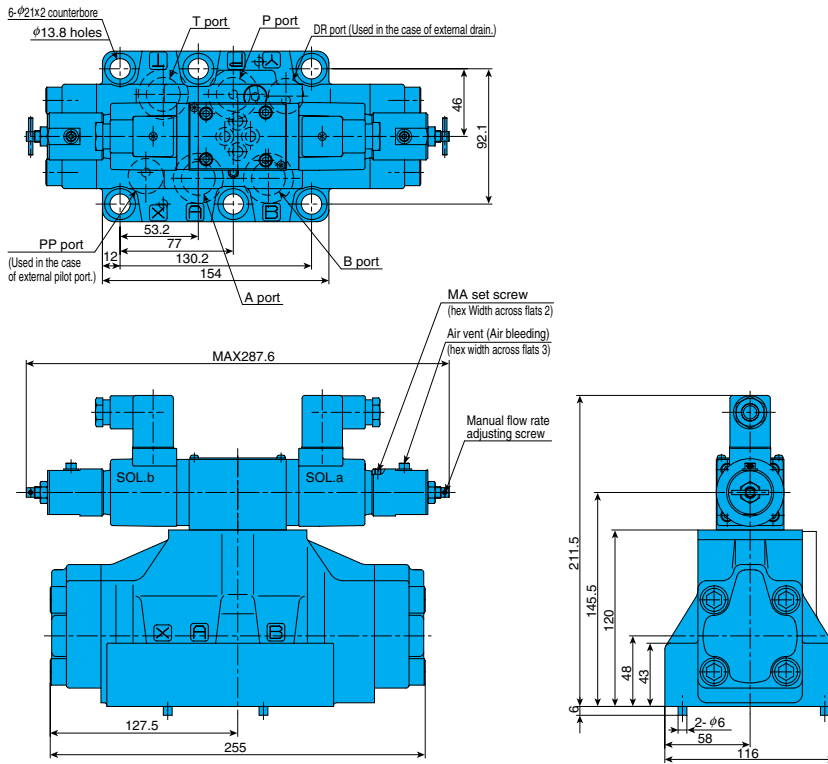

## Performance Curves

Hydraulic Operating Fluid Viscosity 32mm<sup>2</sup>/s

Input Current – Flow Rate Characteristics are characteristic when the P→A or P→B pressure drop is  $\Delta P = 1.0\text{MPa}$  (10kgf/cm<sup>2</sup>).

For Pressure – Flow Rate Characteristics, the horizontal shaft valve differential pressure indicates the pressure drop volume of the entire control valve

(between P, A, B, T), and flow rate is measured at the oil motor.

### Input Current – Flow Rate Characteristics

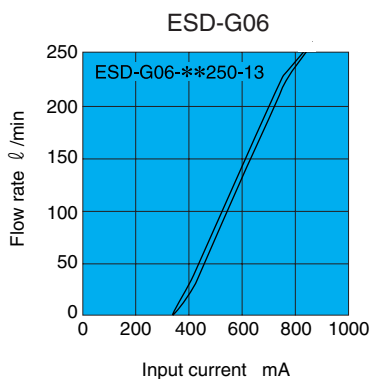
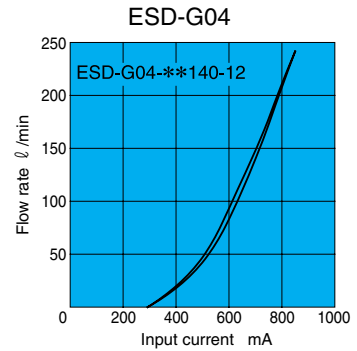
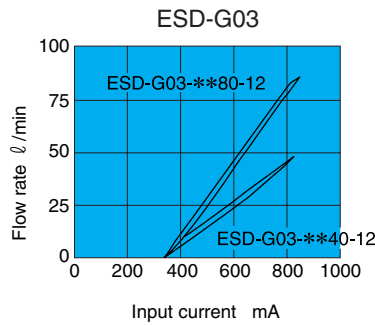
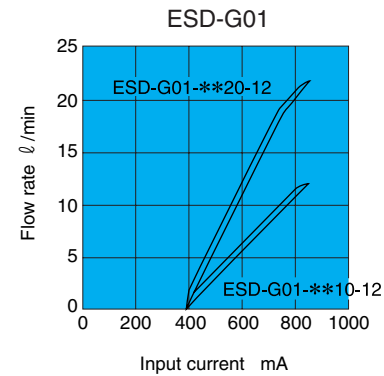

Pressure – Flow Rate Characteristics

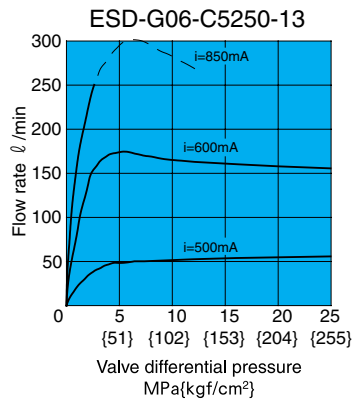
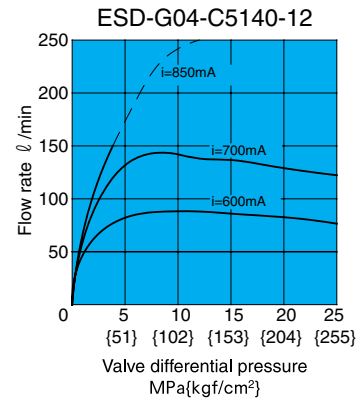
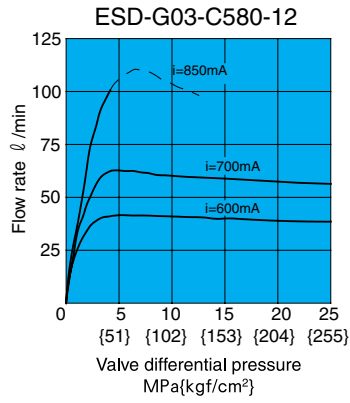
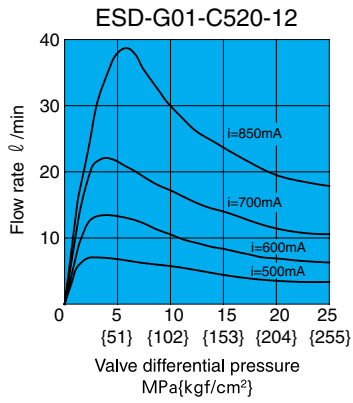

**Cross-sectional Drawing**

ESD-G01-\*\*\*\*-12

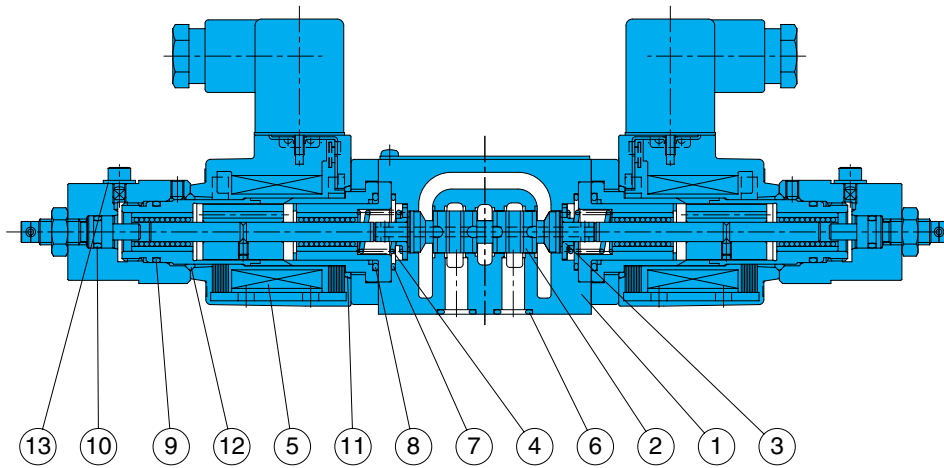

Part No.	Part Name
1	Body
2	Spool
3	Retainer
4	Spring
5	Coil
6	O-ring
7	O-ring
8	O-ring
9	O-ring
10	O-ring
11	O-ring
12	O-ring
13	Seal

Note)  
Coil model number JD64-D2

Seal Part List (Kit Model Number JDS-G01-1A)

Part No.	Part Name	Part Number	Q'ty
6	O-ring	AS 568-012(Hs90)	4
7	O-ring	AS 568-019(Hs90)	2
8	O-ring	1B-P22	2
9	O-ring	AS 568-016(Hs90)	2
10	O-ring	1B-P7	2
11	O-ring	S-25	1
12	O-ring	1A-P20	1
13	Seal	CW1000F0	2

Note)O-ring 1A/B-\*\* refers to JIS B2401-1A/B-\*\*.

ESD-G03-\*\*\*-(\*\*)-12

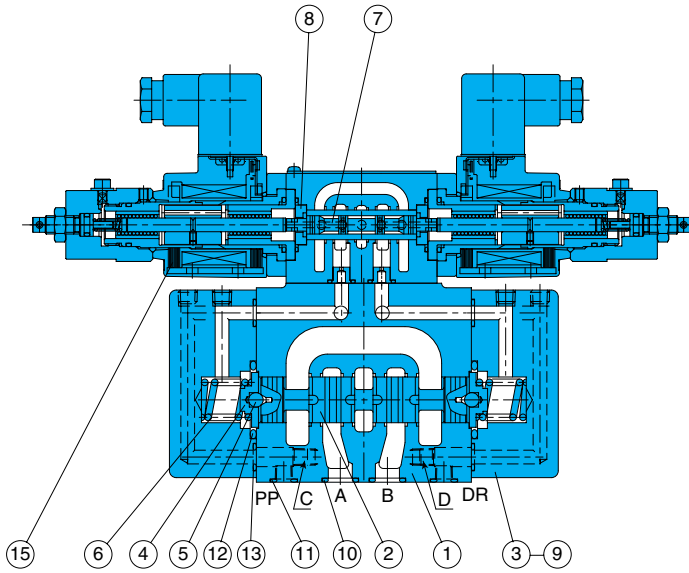

Manual adjustment section  
(ESD-G03, G04, G06, G10)

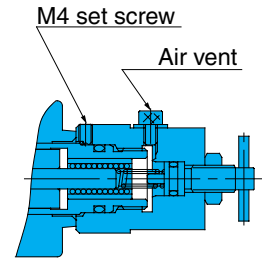

Note) The coil cover has an M4 set screw. When changing the orientation of the air vent, loosen the M4 screw and rotate the cover. Retighten after bleeding the air.

Methods for Changing the Pilot/Drain System

After Change		Hexagon Socket Head Plug
Pilot	Internal	Change to PP port from C.
	External	Change from PP port to C.
Drain	Internal	Change from D to DR port.
	External	Change from DR port to D.

ESD-G04-\*\*\*-(\*\*)-12

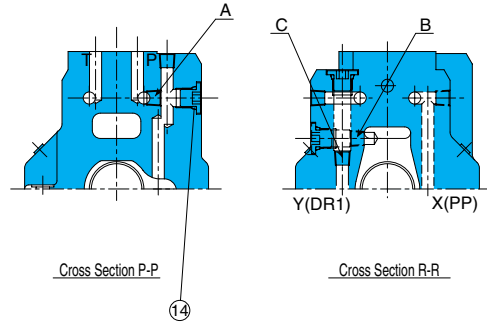
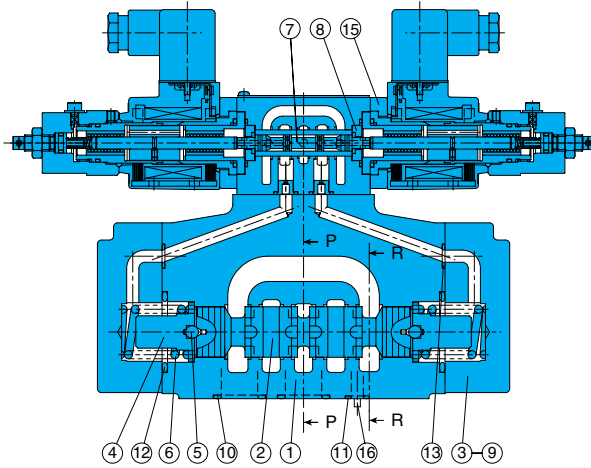

Part No.	Part Name
1	Body
2	Spool
3	Cover
4	Retainer
5	Ball
6	Spring
7	Pilot spool
8	Stopper
9	Screw
10	O-ring
11	O-ring
12	O-ring
13	O-ring
14	O-ring
15	Proportional solenoid

Note) Coil model number JD64-D2

Methods for Changing the Pilot/Drain System

After Change		Hexagon Socket Head Plug
Pilot	Internal	Remove from (A)
	External	Insert from (A)
Drain	Internal	Change from (B) to (C)
	External	Change from (C) to (B)

Note) A single hex head plug (NPTF 1/16) is required when changing to external pilot. Hex Head Plug: TPUA-1/16

Seal Part List (Kit Model Number JHS-\*\*)

Part No.	Part Name	ESD-G03		ESD-G04	
		Part Number	Q'ty	Part Number	Q'ty
10	O-ring	1B-P12	5	1B-P22	4
11	O-ring	1B-P9	2	1B-P10A	2
12	O-ring	1B-P28	2	1B-P34	2
13	O-ring	1B-P9	6	1B-P9	2
14	O-ring	—	—	1B-P8	3
Kit Model No.		JHS-G03		JHS-G04	

Note) O-ring 1B-\*\* refers to JIS B 2401-1B-\*\*.

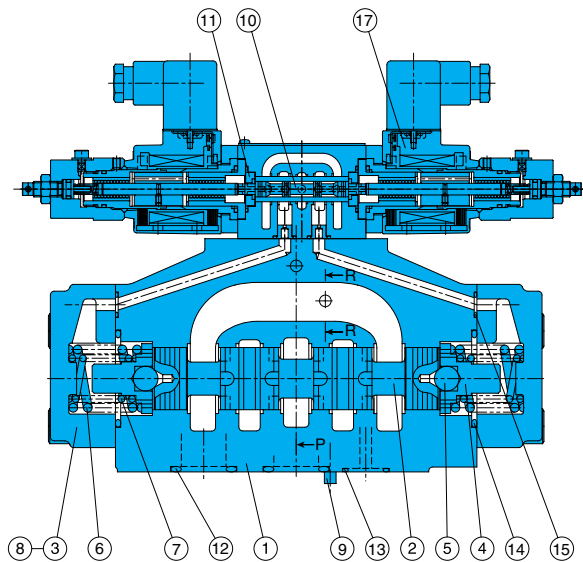

Pilot, Drain System Change

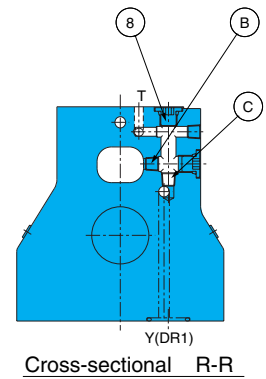
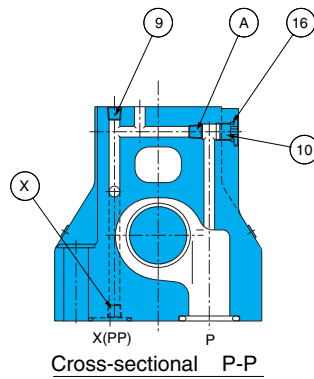

Changing the Pilot and Drain Connections

After Change		Hexagon Socket Head Plug
Pilot	Internal	Switch from (A) to (X).
	External	Switch from (X) to (A).
Drain	Internal	Switch from (B) to (C).
	External	Switch from (C) to (B).

Seal Part List (Kit Model Number JHS-G06)

Part No.	Part Name	Part Number	Q'ty
12	O-ring	1B-P28	4
13	O-ring	1B-P20	2
14	O-ring	1B-G45	2
15	O-ring	1B-P10	2
16	O-ring	1B-P8	3

Note) O-ring 1B-\*\* refers to JIS B 2401-1B-\*\*.

Part No.	Part Name
1	Body
2	Spool
3	Cover
4	Retainer
5	Ball
6	Spring
7	Spring
8	Screw
9	Pin
10	Pilot spool
11	Stopper
12	O-ring
13	O-ring
14	O-ring
15	O-ring
16	O-ring
17	Proportional solenoid

## Pressure compensation valve kit

### Specifications

Item	Model No.	JHF-01027	JHF-03040(E)	JHF-03080(E)	JHF-06170(E)
Maximum Operating Pressure MPa(kgf/cm <sup>2</sup> )		21{214}	25{255}	25{255}	21{214}
Pressure Compensation Differential Pressure MPa(kgf/cm <sup>2</sup> )		1.0{10}	0.6{6}	1.4{14}	0.8{8}
Maximum Flow Rate ℓ/min		27	40	80	170
Weight kg		1.5	4.7	5.0	12

### Understanding Model Numbers

JHF - 03 040 (E)

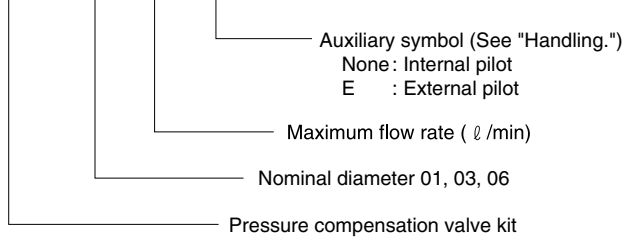

#### ● Handling

① When using the pressure compensation kit, use an external pilot type for the ESD valve (G03, 06).

② An internal pilot type pressure compensation valve kit is used when the pilot flow rate is supplied from the P port, without an external pilot port (Pp port) on the manifold. An

external pilot type pressure compensation valve kit is used when there is an external pilot port (Pp port) on the manifold.

### Installation Dimension Drawings

Pressure compensation valve kit  
JHF-01027

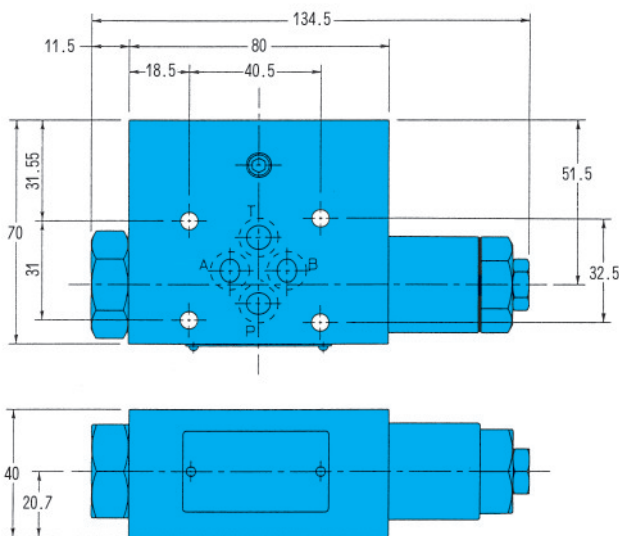

JHF-03040(E)

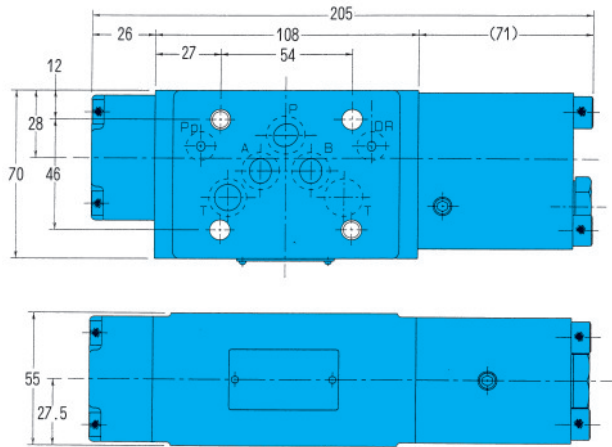

JHF-03080(E)

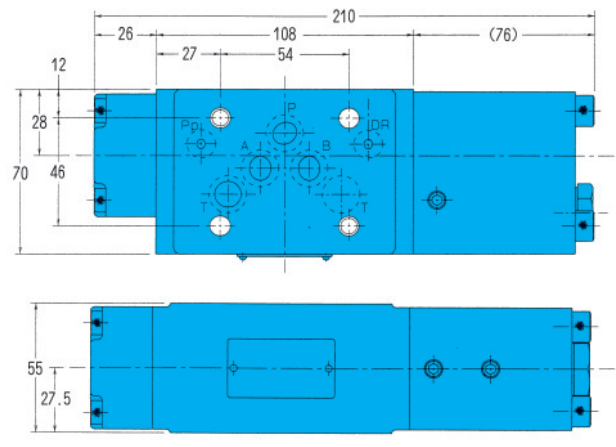

JHF-06170(E)

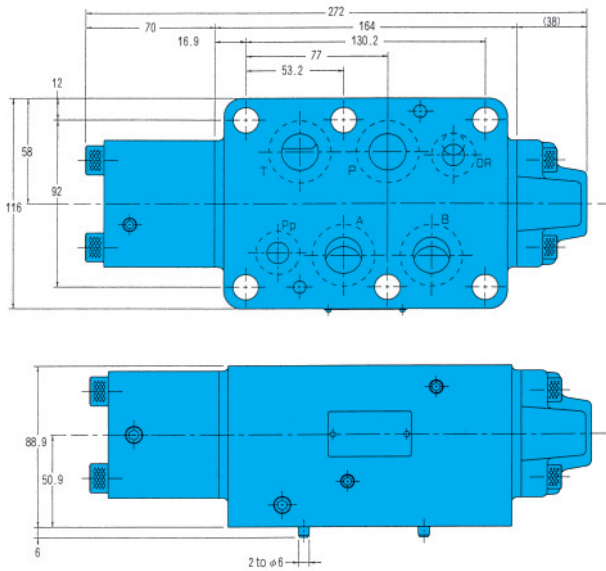

Note) Mounting bolts are not included with the pressure compensation kit. Use the valve mounting bolt lists on pages D-93 through D-95 to select mounting bolts.

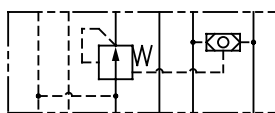

Internal pilot

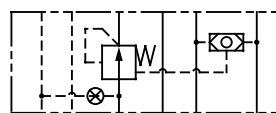

External pilot