



廣瀬バルブ工業

圧力補償付スロットルチェックバルブ

FVP-720

寸法図

FVP-720-T02~T06-12

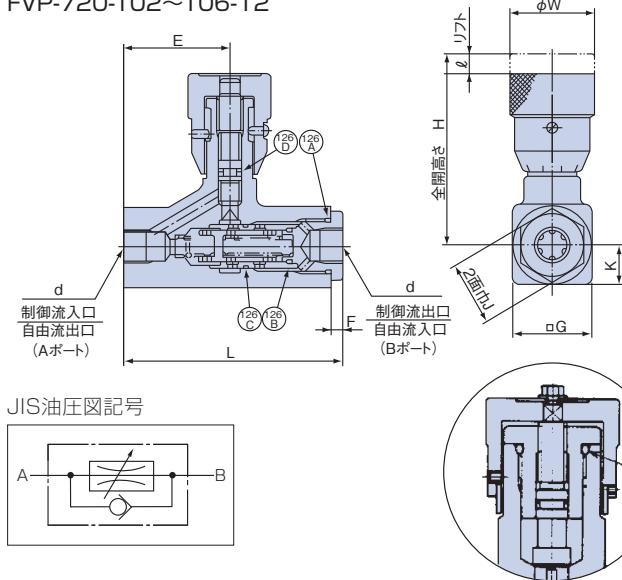

仕様

最高使用圧力	21MPa
圧力補償最低作動圧力	0.6MPa
圧力による流量変化	±5% (最大調整流量の20%以下に於いては流量変化±10%)
フリーフローチェック弁クラッキング圧力	0.1MPa以下

流量調整範囲

モデルナンバ	流量調整範囲(L/min)
FVP-720-T02-12	1~13
FVP-720-T03-12	1~23
FVP-720-T04-12	2~38
FVP-720-T06-12	6~90

寸法表

モデルナンバ	d	L	E	F	G	J	K	リフト ℓ	W	H	質量 (kg)	Oリング呼び番号				
												JIS B 2401			JASOF 404	
												126A	126D	126E	126B	126C
FVP-720-T02-12	Rc1/4	90	41.5	5	32	27	16	6	27	69	0.8	P18	P 5	—	1011	1014
FVP-720-T03-12	Rc3/8	100	48	5	36	30	18	8	38	85	1.2	P21	P 7	—	1012	1017
FVP-720-T04-12	Rc1/2	120	61.5	7	41	36	20.5	10	48	105.5	2.0	P24	P10A	—	1014	1019
FVP-720-T06-12	Rc3/4	150	68	10	50	41	25	12	55	116	3.5	P32	P10	P24	JIS B 2401 P21 G25	

圧力—制御流量特性 (粘度: 46mm²/s)

T02

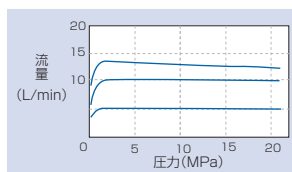

T03

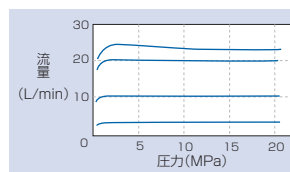

T04

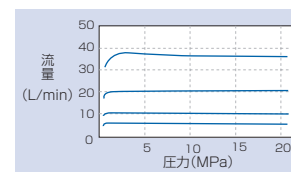

T06

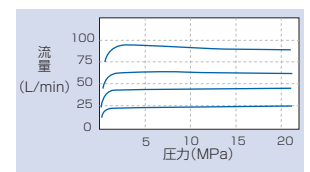
開度—制御流量特性 (粘度: 46mm²/s)

T02

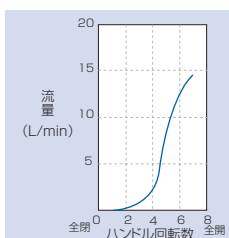

T03

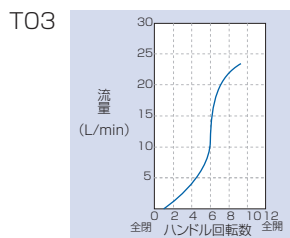

T04

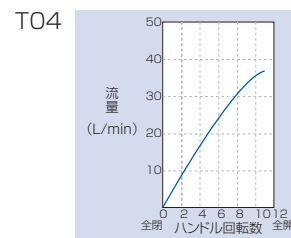

T06

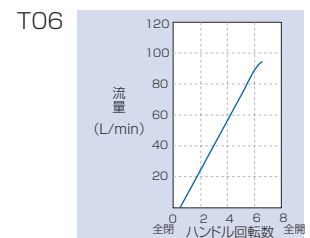
自由流圧力降下特性 (粘度: 46mm²/s)

T02

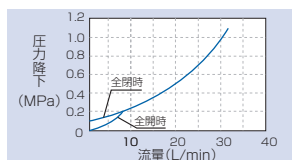

T03

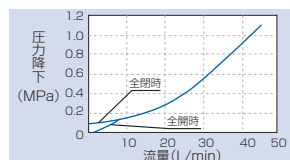

T04

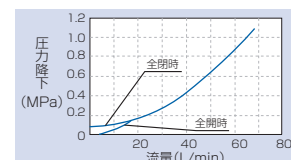

T06

